



# Fender Eliminator Kit

**APPLICATION**

<b>MAKE</b>	<b>MODEL</b>
HONDA	CBR250R CBR300R

**PRODUCT**

070BG122501	Fender Eliminator Kit
-------------	-----------------------

 **This product is not DOT approved. Yoshimura R&D of America, Inc. is not liable or responsible for any resulting event caused by the installation of this product. Check with local laws and regulations for compliance prior to installation and use. This product is not intended for use on public highways.**

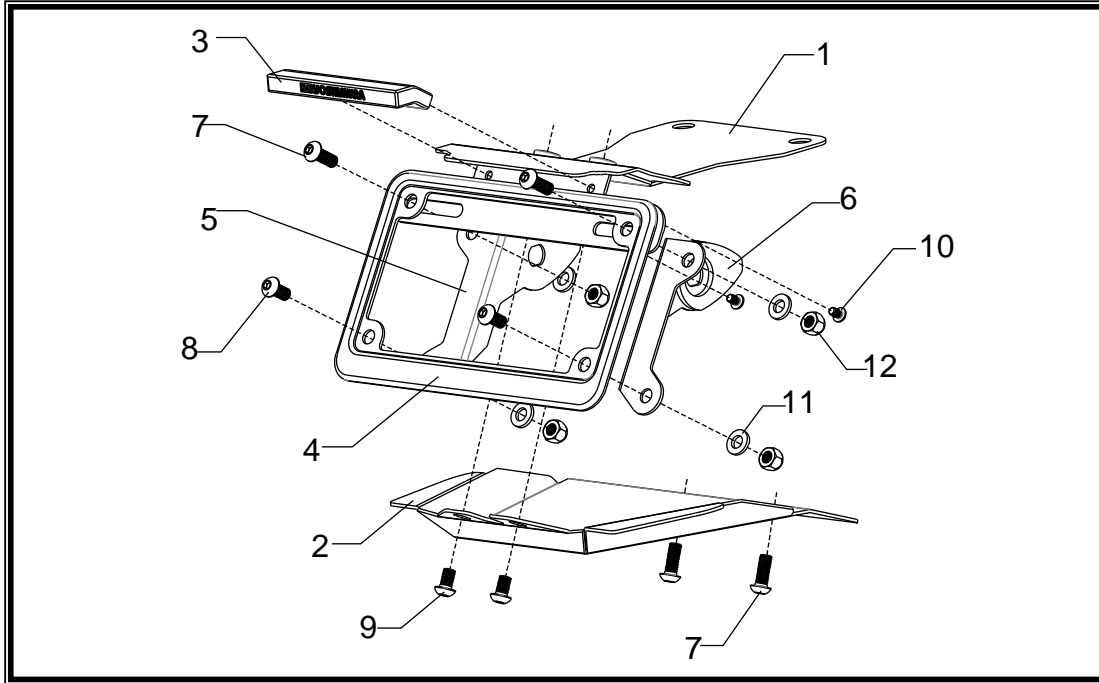

No.	Part #	Description	Qty
1	12250-FEBKT	Yoshimura Fender Eliminator Bracket	1
2	12250-FEB-00	Yoshimura Fender Eliminator Cowl	1
3	070BG-LH-K	Yoshimura LED Fender Eliminator Light	1
4	070BG-LPF	Yoshimura License Plate Frame	1
5	12250-TSBL-01	Left Turn Signal Bracket	1
6	12250-TSBR-01	Right Turn Signal Bracket	1
7	M6X16BHS	6mm x 16mm Button Head Cap Screw	4
8	M6X14BHS	6mm x 14mm Button Head Cap Screw	2
9	M6X10BHS	6mm x 10mm Button Head Cap Screw	2
10	M4X6BHS	4mm x 6mm Button Head Cap Screw	2
11	6MMWASHER	6mm Washer	4
12	6MMLN	6mm Nylon Lock Nut	4
**	94785-01-ND	Butt Connectors	2
**	17029	Yoshimura Sticker Sht	1

## **-TOOLS REQUIRED-**

**Metric Socket Set • Combination Wrench Set • Metric Allen Wrench Set • Screwdriver**

## **-REMOVAL-**

1. Remove passenger seat and disconnect rear tail light, turn signal, and license plate harness plug.
2. Remove the (4) passenger grab handle bolts and remove grab handles. See Fig 1.
3. Remove the (2) push tabs securing the lower cowl cover and remove to expose the (2) screws. Remove the (2) screws. See Fig 2.
4. Remove stock tail light assembly by first removing the (3) screws securing the tail light cover and remove. See Fig 3. Then remove the (4) screws securing the tail light assembly and remove tail light by pulling out toward rear of bike. See Fig 4, 5.
5. Remove stock fender assembly by removing the (3) bolts securing fender in place. See Fig 6. (The 3<sup>rd</sup> bolt is beneath the tail light, not pictured but accessible after removing the tail light assembly.)

**Note: The stock fender assembly support bracket with the rubber grommets will not be re-used.**

6. Remove stock turn signals from fender assembly.

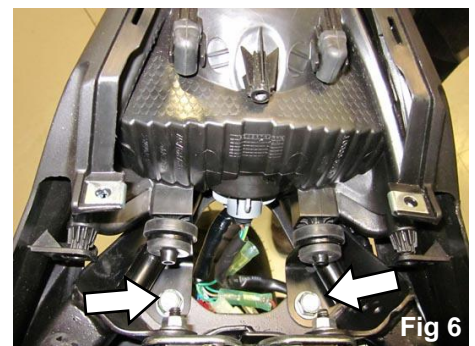
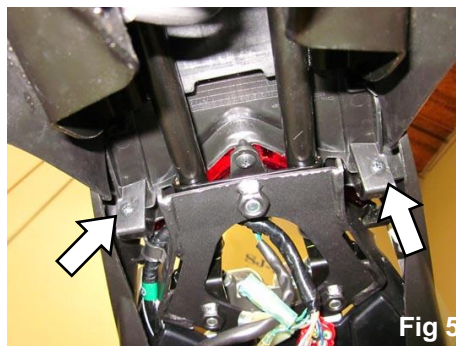
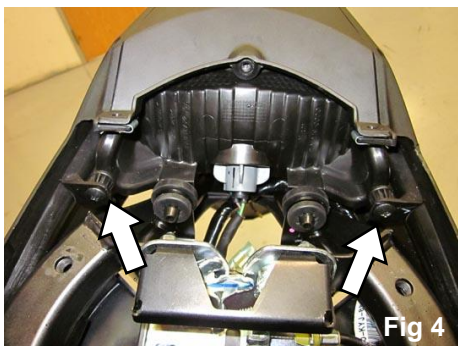
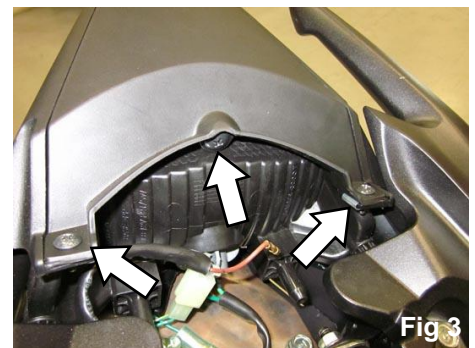
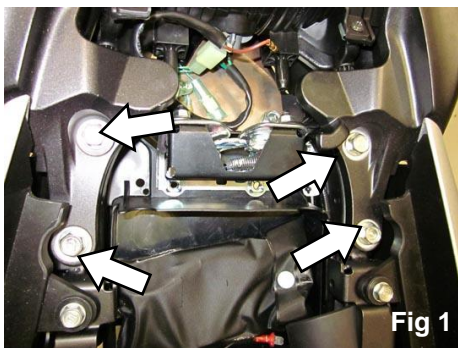

## ***-INSTALLATION-***

1. *Install Yoshimura LED fender eliminator light according to the diagram using the (2) provided 4mm screws.*
2. *Install the Yoshimura license plate bracket to the stock subframe using the (3) stock bolts. See Fig 7.*
3. *Re-install stock tail light assembly using the reverse steps of removal.*

**Note:** *The stock fender assembly support bracket must be removed in order to install the Yoshimura Fender Eliminator Bracket.*

4. *Install turn signals onto Yoshimura turn signal brackets and route the wires through the opening on the Yoshimura license plate bracket and re-connect wires accordingly by color.*
5. *Cut the stock license plate light connector from the stock fender. Be sure to cut at least a 6" section of wire from the connector. Using the connectors in the kit, connect the Yoshimura Fender Eliminator wires to the stock license plate light connector as follows: Red wire goes to the brown wire; Black wire goes to the green wire.*
6. *Install Yoshimura fender eliminator cowl using the (4) provided bolts. See diagram and Fig 8 for orientation.*
7. *Re-install passenger seat.*
8. *Check for function of license plate light and turn signals and that all brackets and components are secure prior to riding.*

