



SIGNATURE SERIES

Qualified Manufacturer Declared "Replacement Part"

APPLICATION

YEAR	MODEL
2011-2020	Suzuki GSX-R600/750
PRODUCT	
11600E0220	R77 Stainless Steel Slip-On Exhaust System with Carbon Fiber Sleeve; Carbon Fiber Endcap
11600E0520	R77 Stainless Steel Slip-On Exhaust System with Stainless Steel Sleeve; Carbon Fiber Endcap

- This product is 50-state legal and complies with Federal and State regulations. Any attempts to modify this product will render it non-compliant with Federal law and void warranty. If modified, the vehicle can no longer be used on public roads and can only be used for off-highway closed course competition. In the state of California, it is illegal to modify the emission control system, which includes the fuel injection system of any vehicle.
- You must know how to remove and replace your stock exhaust in order to install this product otherwise have it installed by a professional mechanic. Keep all stock parts from your existing system as some components may be necessary to install your new Yoshimura exhaust depending on the application.
- Read through all instructions before beginning installation. Exhaust system can be extremely hot. Let motorcycle cool down before beginning installation. Always wear hand and eye protection and take precautionary measures to avoid injury.

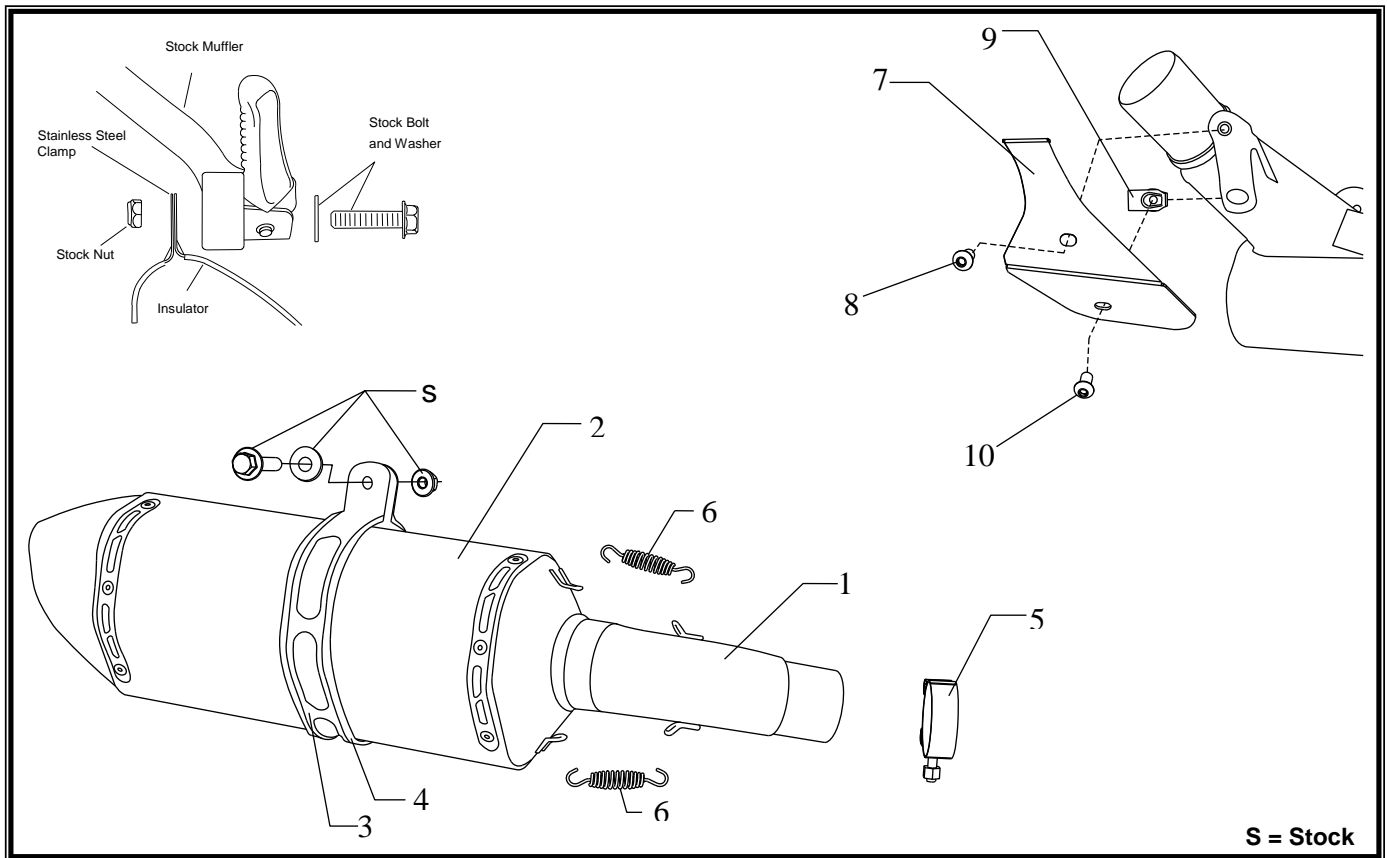

No.	Part #	Description	Qty
1	11600-435	Yoshimura Tailpipe	1
2	N/A	Yoshimura Muffler CF Sleeve; CF Endcap SS Sleeve; CF Endcap SS Sleeve; SS Endcap	1
3	1121-MPCA 1121-MPCAX	Muffler Clamp CF Sleeve SS Sleeve	1
4	HT SHLDR77	Muffler Clamp Heatshield	1
5	27-61M	Exhaust Clamp	1

6	RACE-82MM	82mm Springs	2
7	11600-HS	Yoshimura Heatshield	1
8	M6X10BHS	6mm x 10mm Button Head Screw	1
9	M6X1U	6mm x 1.0 U-Nut	1
10	M6X12BHS	6mm x 12mm Button Head Screw	1
**	ST-200	Spring Puller Tool	1
**	17029	Yoshimura Sticker Sht	1

-TOOLS REQUIRED-

Metric Socket Set • Combination Wrench Set • Torque Wrench • Metric Allen Wrench Set

-REMOVAL-

1. **Remove stock heatshield by removing the heatshield screw.**
2. **Remove the stock rubber grommet on the heatshield bracket.**
3. **Loosen exhaust clamp.**
4. **While supporting the muffler securely, remove the muffler mount bolt.**
5. **Slide the stock muffler assembly off midpipe.**

-INSTALLATION-

1. *Small parts installation.*
 - a) **Install U-Nut provided in the kit on the lower hole of the stock heatshield bracket where the stock rubber grommet was removed.**
 - b) **Install rubber heatshield on muffler clamp. See diagram for reference. (Note: Some trimming of the heatshield may be required.)**
 - c) **Slide muffler clamp over Yoshimura muffler.**
2. *Installing the Yoshimura muffler assembly.*
 - a) **Slide provided exhaust clamp over Yoshimura tailpipe.**
 - b) **Slide Yoshimura Slip-On System onto stock midpipe.**
 - c) **Align muffler mount and bolt using stock bolts. (Note: If necessary, remove springs on tailpipe to muffler to twist and align properly.)**
 - d) **Tighten and torque exhaust clamp to 21 ft-lb. (29Nm, 2.9kgf-m)**
 - e) **Tighten and torque muffler mount to 33 ft-lb. (45Nm, 4.5kgf-m)**
 - f) **Install Yoshimura heatshield using the (2) provided 6mm x 10mm screws.**
3. *Fitment check and Notes.*
 - a) **Before starting motorcycle, check for proper clearance between new exhaust system and rear suspension (i.e. tire, swing-arm, brake, rear shock, engine, and etc.) If any problem is found, please carefully follow through the installation steps again. If problem still persists, please call Yoshimura Tech Department at (800) 634-9166 / in CA (909) 628-4722.**
 - b) **It is recommended that the muffler and tailpipe be wiped down with rubbing alcohol to remove oil and fingerprints. This will help prevent tarnishing of the finish after the exhaust is heated up.**
 - c) **NOTE: After starting motorcycle, it is normal for new exhaust system and muffler to emit smoke until oil residue burns off.**

NOISE EMISSION WARRANTY

Yoshimura warrants that this exhaust system, at time of sale, meets all applicable U.S. E.P.A. Federal noise standards. This warranty extends to the first person who buys this exhaust system for purposes other than resale, and to all subsequent buyers. Warranty claims should be directed to Yoshimura R&D of America, Inc.
5420 Daniels St. Chino, CA 91710 | Tel (800) 634-9166

TAMPERING PROHIBITION

Federal law prohibits any modification to this exhaust system which causes the motorcycle to exceed the Federal noise standard. Use of the motorcycle with such a modified exhaust system is also prohibited.

Acts likely to constitute tampering include removal or puncturing the muffler, baffles, header pipes, or any other component which conducts exhaust gases.

WARNING: This product should be checked for repair or replacement if the motorcycle noise has increased significantly through use. Otherwise, the owner may become subject to penalties under state and local ordinances.