



YOSHIMURA

RESEARCH&DEVELOPMENT OF AMERICA, INC.

5420 DANIELS STREET STE A, CHINO CA., 91710 · (800) 634-9166 · (909) 628-4722 · FACSIMILE (909) 591-2198

www.yoshimura-rd.com

Signature Series

Qualified Manufacturer Declared "Replacement Part"

2015~2019

Yamaha YZF-R1

13141EM220 (CF/CF)

13141EM520 (SS/CF)

Alpha Stainless Steel Slip-On



Signature Series systems are:

- CARB/EPA tail-pipe emissions compliant.
- Marked with appropriate EPA noise labels.
- Independent laboratory tested for EPA new vehicle noise compliance.



✘ You must know how to remove and replace your stock exhaust in order to install this product otherwise have it installed by a professional mechanic. Keep all stock parts from your existing system as some components may be necessary to install your new Yoshimura exhaust depending on the application. Read through all instructions before beginning installation. Exhaust system can be extremely hot. Let motorcycle cool down before beginning installation. Always wear hand and eye protection and take precautionary measures to avoid injury. ✘

NOTE: IN THE STATE OF CALIFORNIA, IT IS ILLEGAL TO MODIFY THE EMISSION CONTROL SYSTEM, WHICH INCLUDES THE CARBURETORS OF ANY VEHICLE.

Assembly Diagram

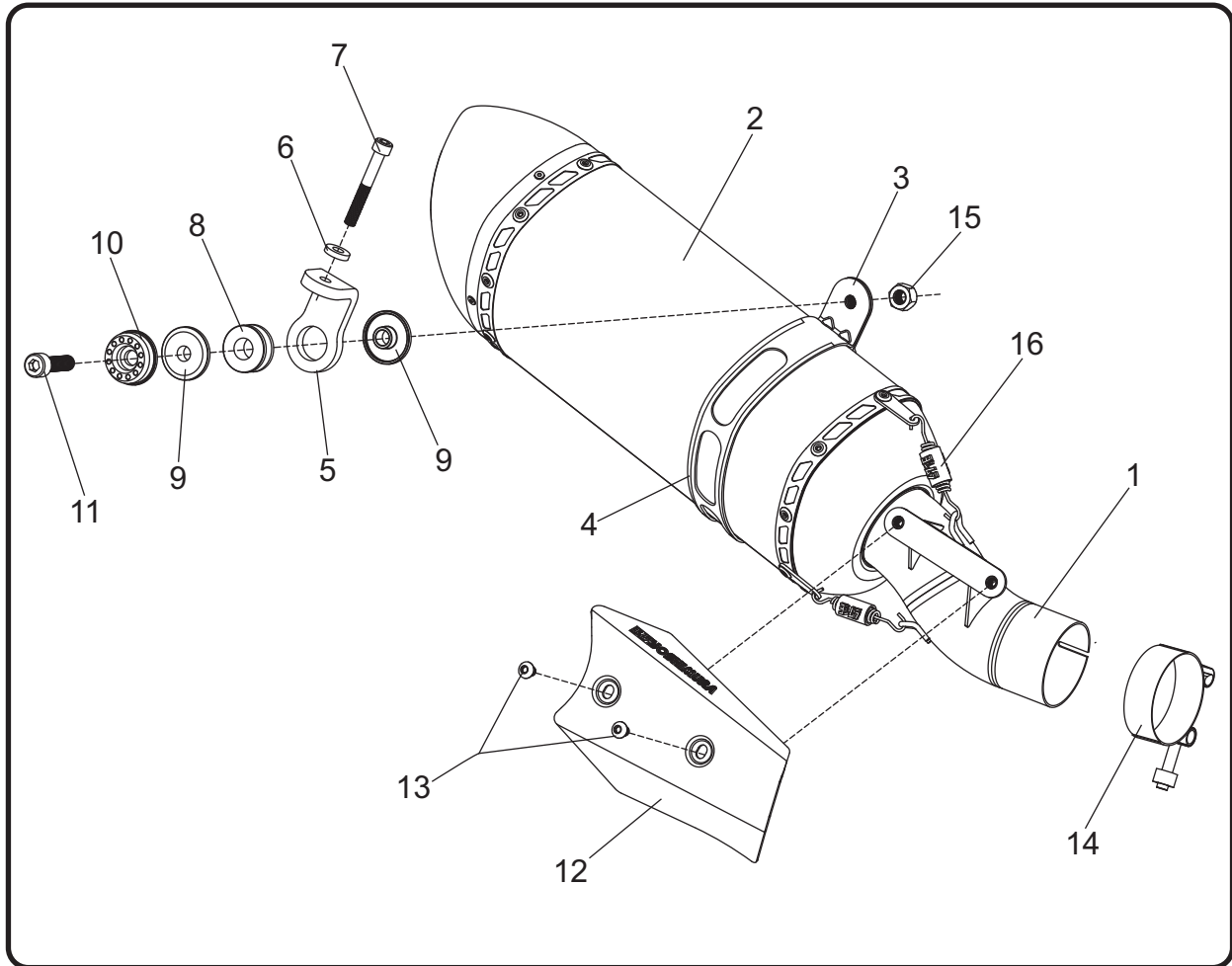

No.	Item	Description	Qty.
1	13141-436	Yoshimura Tailpipe	1
2	****	Yoshimura Signature Series Muffler	1
3	MCYM5-GCBX(-X)	Muffler Clamp	1
4	HT SHLDR77	Muffler Clamp Heat Insulator	1
5	13141-436-BKT	Muffler Mount Bracket	1
6	13141-435-SPCR	Muffler Bracket Spacer	1
7	M6X45	6mm x 45mm Socket Head Cap Bolt	1
8	Z1023	Rubber Grommet	1
9	ALS-043	Aluminum Spacer	2
10	M8ALCSW-00	8mm Aluminum Countersink Washer	1
11	M8X30	8mm x 30mm Socket Head Cap Bolt	1
12	13141-436-HS	Muffler Heatshield	1
13	RC116HSB-BK	6mm x 8mm Flanged Heatshield Bolts	2
14	20067	Exhaust Clamp	1
15	8MMLN	8mm Lock Nut	1
16	RACE-SPS-1	Medium Exhaust Spring	2
**	ST-200	Spring Puller Tool	1
**	17029	Sticker Sheet	1

** Not shown on the diagram.

**** Signature Series muffler replacement part number unavailable. Repair or replacement of Signature Series exhaust systems is only available directly through Yoshimura R&D of America, Inc.
 (-X) Used for Stainless Steel canister.

Removal

1. Remove the stock exhaust clamp between the header and muffler assembly.
2. While securely supporting the stock muffler, remove the muffler mount bolt and carefully remove the stock muffler assembly by sliding toward the rear of motorcycle.

Note¹: The stock muffler ring stopper and exhaust gasket will not be used with the slip-on system.

Note²: The stock muffler bracket on the right footpeg will not be used. Remove if desired.

3. Remove the right side passenger footpeg bolt by removing the footpeg nut.

Note: To prevent loss of small footpeg assembly components, do not disassemble or remove the footpeg from bracket.

Installation

1. Install (No. 7) *M6X45*, bolt through the passenger footpeg and bracket.
2. Install (No. 8) *Z1023*, rubber grommet onto (No. 5) *13141-436-BKT*, muffler mount bracket.

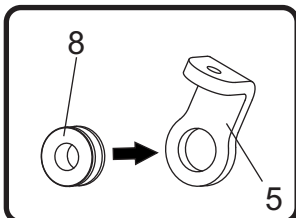

3. Install (No. 5) *13141-436-BKT*, muffler mount bracket and (No. 6) *13141-435-SPCR*, spacer to the footpeg bracket using the stock footpeg nut as shown below.

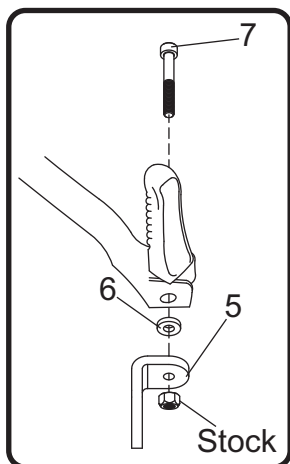

4. Install (No. 9) *ALS-043*, aluminum spacer onto (No. 8) *Z1023*, rubber grommet as shown.

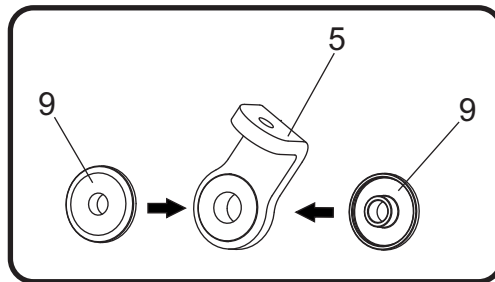

5. Install (No. 4) *HT SHLDR77*, muffler clamp heat insulator onto (No. 3) *MCYM5-GCBX(-X)*, muffler clamp.

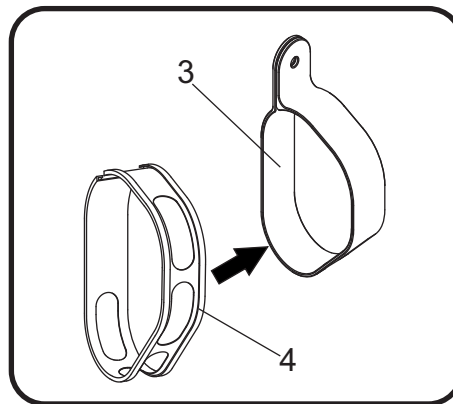

6. Install (No. 14) *20067*, exhaust clamp over (No. 1) *13141-436*, tailpipe inlet.

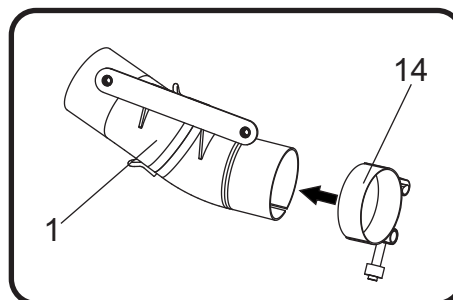

7. Install muffler assembly by sliding (No. 1) *13141-436*, tailpipe inlet over the stock header outlet.
8. Slide (No. 3) *MCYM5-GCBX(-X)*, muffler clamp over muffler assembly and align to (No. 5) *13141-436-BKT*, muffler mount bracket.
9. Secure muffler to (No. 5) *13141-436-BKT*, muffler mount bracket using (No. 11) *M8X30*, bolt, (No. 10) *M8ALCSW-00*, countersink washer, and (No. 15) *8MMLN*, lock nut. See assembly diagram for proper orientation and order of hardware.

10. Install (No. 12) *13141-436-HS*, heatshield onto (No. 1) *13141-436*, tailpipe using the provided (No. 13) *RC116HSB-BK*, heatshield bolts. See assembly diagram for proper heatshield orientation.

Note: Check proper alignment of (No. 12) *13141-436-HS*, muffler heatshield to the stock header heatshield. Remove (No. 16) *RACE-SPS-1*, exhaust springs to rotate the tailpipe independently from the muffler if necessary.

11. Torque (No. 7) *M6X45*, footpeg bolt to factory specification.

12. Torque (No. 11) *M8X30*, bolt to 20 Nm (2.0 kg-m, 15 ft-lb).

13. Torque (No. 14) *20067*, exhaust clamp to 8.5 Nm (0.86 kg-m, 6 ft-lb).

14. Before starting motorcycle, check for proper clearance between new exhaust system and rear suspension (i.e. tire, swing arm, brakes, rear shock, and etc.) If any problem is found, please carefully follow through the installation steps again. If problem still persists, please call Yoshimura Tech Department at (800) 634-9166 / in CA (909) 628-4722.

15. It is recommended that the muffler and tailpipe be wiped down with rubbing alcohol to remove oil and fingerprints. This will help prevent tarnishing of the finish after the exhaust is heated up.

Note: After starting motorcycle, it is normal for new exhaust system and muffler to emit smoke until oil residue burns off.

NOISE EMISSION WARRANTY

Yoshimura warrants that this exhaust system, at time of sale, meets all applicable U.S. E.P.A. Federal noise standards. This warranty extends to the first person who buys this exhaust system for purposes other than resale, and to all subsequent buyers. Warranty claims should be directed to Yoshimura R&D of America, Inc. 5420 Daniels St. Chino, CA 91710 | Tel (800) 634-9166

TAMPERING PROHIBITION

Federal law prohibits any modification to this exhaust system which causes the motorcycle to exceed the Federal noise standard. Use of the motorcycle with such a modified exhaust system is also prohibited.

Acts likely to constitute tampering include removal or puncturing the muffler, baffles, header pipes, or any other component which conducts exhaust gases.

WARNING: This product should be checked for repair or replacement if the motorcycle noise has increased significantly through use. Otherwise, the owner may become subject to penalties under state and local ordinances.