



YOSHIMURA

RESEARCH&DEVELOPMENT OF AMERICA, INC.

5420 DANIELS STREET STE A, CHINO CA 91710 · (800) 634-9166 · (909) 628-4722 · FAX (909) 591-2198

WWW.YOSHIMURA-RD.COM

Signature Series

Qualified Manufacturer Declared "Replacement Part"

2019 ~ 2020

SUZUKI RM-Z250

218320D320 (SS/AL)

RS4 Stainless Steel Full-System

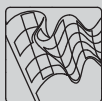

Signature Series systems are:

- CARB/EPA tail-pipe emissions compliant.
- Marked with appropriate EPA noise labels.
- Independent laboratory tested for EPA new vehicle noise compliance.

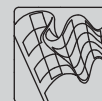

CAUTION: The muffler packing on this system **MUST** be replaced every 6-8 hours of use, or every 1-2 motos. Failure to follow recommended muffler re-packing interval can cause muffler damage and may void the warranty.



NOTE: IN THE STATE OF CALIFORNIA, IT IS ILLEGAL TO MODIFY THE EMISSION CONTROL SYSTEM, WHICH INCLUDES THE FUEL INJECTION OF ANY VEHICLE.

Assembly Diagram

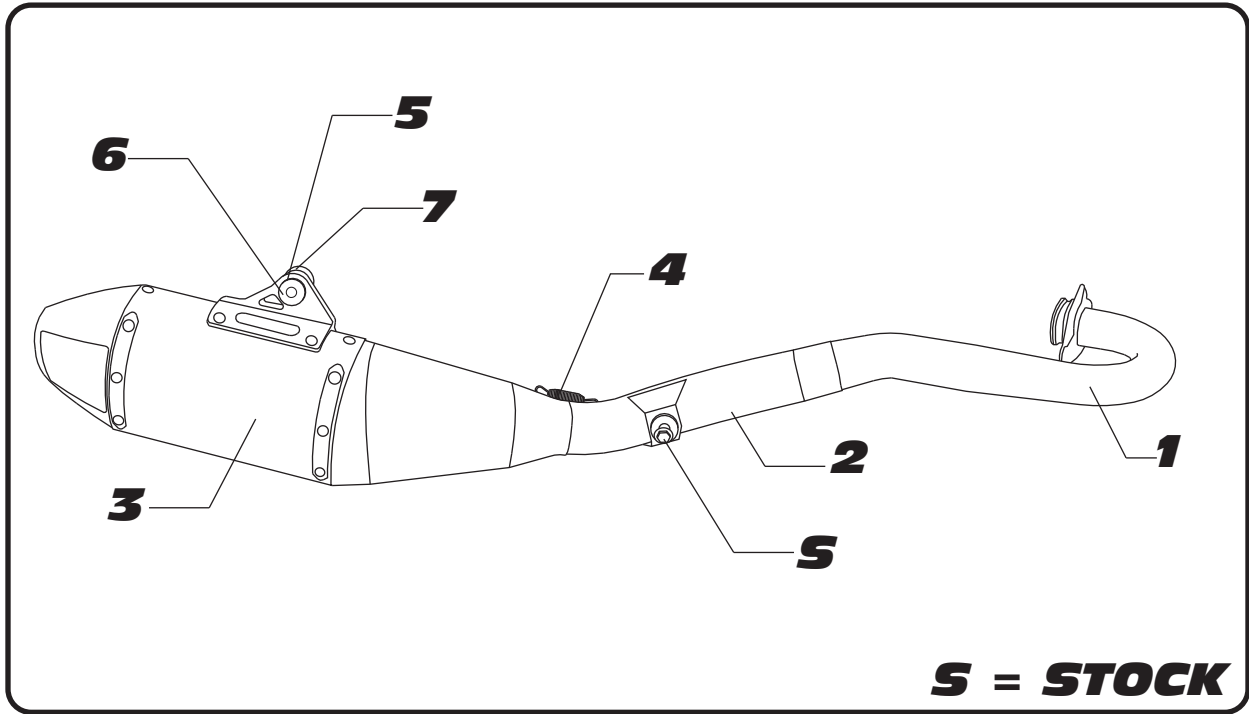

NO.	DESCRIPTION	QTY	PART #
1	Yoshimura Stainless Steel Header	1	21832-101
2	Yoshimura Tailpipe	1	21832-144
3	Yoshimura Race Muffer with Aluminum Sleeve	1	218322D320-RMA
4	Short Exhaust Spring	1	RACE-SPX-2
5	Muffer Mount Rubber Grommet	1	Z1023
6	Aluminum Spacer	1	ALS-043
7	Aluminum Spacer	1	ALS-059
**	AMA 94dB Sound Insert (Installed)	1	INS-21-K
**	Spring Puller Tool	1	ST-200
**	Yoshimura Vinyl Sticker	1	17100
**	Muffer Wash Plug	1	347PLUG
OPTIONAL REPLACEMENT PARTS			
Spark Arrestor		SA-04-K	
Re-pack Kit		REPACK-RS4-PK11	

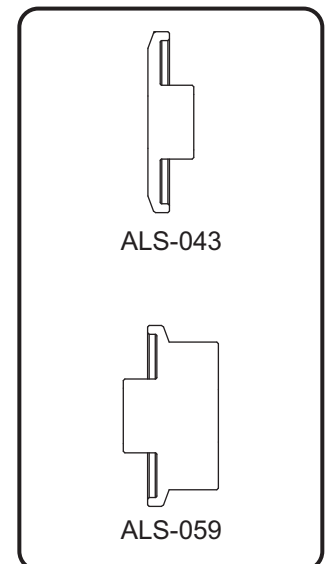

** Not shown on diagram.

CAUTION: Exhaust system can be extremely hot. Let motorcycle cool down before beginning installation. Always wear hand and eye protection and take precautionary measures to avoid injury.

WARNING: Always properly support vehicle with a stand and/or lift when servicing or performing any work. Unstable vehicles may present dangerous conditions and may cause property damage and/or personal injury.

NOTE: Read through all instructions before beginning installation.

Removal

1. Remove right side panel.
2. Loosen exhaust clamp between muffler tailpipe and header connection.
3. Remove forward muffler chassis mount bolt.
4. While securely supporting the stock muffler assembly, remove rear muffler mount bolt and carefully remove muffler from header.
5. Remove header nuts and carefully remove the stock header.

Note: The stock exhaust port gasket will be re-used with the Yoshimura full-system. Inspect and replace if necessary.

Installation

1. Install (No. 5) Z1023, rubber grommet into muffler bracket.

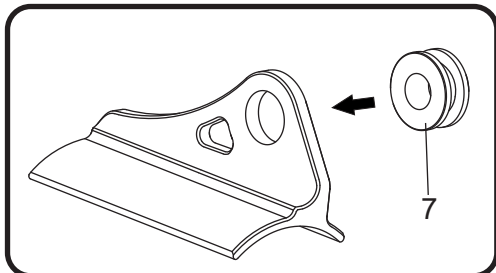

2. Install (No. 6) ALS-043 and (No. 7) ALS-059 aluminum spacers into (No. 5) Z1023, rubber grommet as shown.

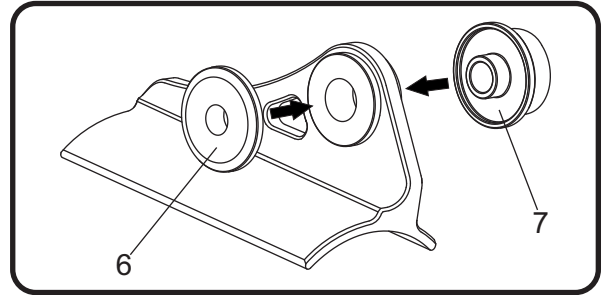

3. Install (No. 1) 21832-101, header using the stock header nuts. Do not torque at this time.
4. Install (No. 2) 21832-144, tailpipe inlet over (No. 1) 21832-101, header outlet and align tailpipe chassis mount bracket to chassis mount. Secure using the stock chassis mount bolt and washer. Do not torque at this time.
5. Install (No. 3) muffler, onto (No. 2) 21832-144, tailpipe outlet and align muffler mount bracket to muffler mount. Secure using the stock muffler mount bolt and washer. Torque muffler mount bolt to factory specification.
6. Torque chassis mount bolt to factory specification.
7. Torque header nuts to factory specification.
8. Install (No. 4) RACE-SPX-2, exhaust spring between muffler and tailpipe using the ST-200, spring puller tool supplied in the kit.
9. Re-install right side panel.
10. Before starting vehicle, check for proper clearance between new exhaust system and rear suspension (i.e. tire, swingarm, brakes, rear shock, and etc.) If any problem is found, please carefully follow through the installation steps again. If problem still persists, please call Yoshimura Tech Department at (800) 634-9166 / in CA (909) 628-4722.
11. It is recommended that the muffler and tailpipe be wiped down with rubbing alcohol to remove oil and fingerprints. This will help prevent tarnishing of the finish after the exhaust is heated up.

Note: After starting motorcycle, it is normal for new exhaust system and muffler to emit smoke until oil residue burns off.



YOSHIMURA

RESEARCH & DEVELOPMENT OF AMERICA, INC.

5420 DANIELS STREET SUITE A, CHINO, CA 91710 · (800) 634-9166 · (909) 628-4722 · FAX (909) 591-2198

www.yoshimura-rd.com

INS-21-K

YOSHIMURA LOW VOLUME SOUND INSERT KIT

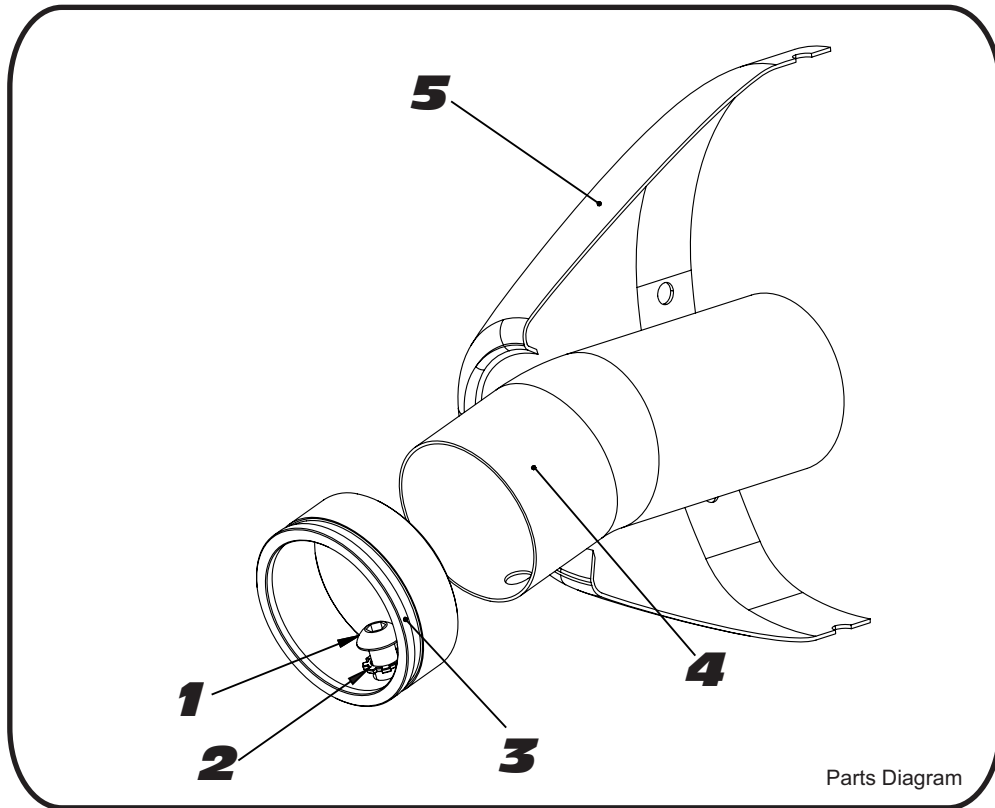

NO.	DESCRIPTION	QTY	PART #
1	6mm X 12mm Button Head Cap Screw	1	M6X12BHS
2	6mm Lock Washer	1	6MMLCKW SHR-TH
3	RS4 Aluminum Insert Ring	1	RS4-RING-1500
4	Low Volume Insert	1	INS-U-2
5	Yoshimura Exhaust	**	**

- 1 Using a 4mm Allen key, remove the bolt that secures the aluminum ring and sound insert to the muffler (see Parts Diagram for location).
- 2 Remove the sound insert from the muffler.
- 3 Inspect the sound insert for cracks or damage and replace if necessary.
- 4 Re-install sound insert and aluminum ring. Torque the sound insert securing bolt to 1.0 kg-m (7.3 lb-ft).
NOTE: It is recommended that a low strength "Loc-tite" is used on the sound insert securing bolt.