



# YOSHIMURA

RESEARCH&DEVELOPMENT OF AMERICA, INC.

5420 DANIELS STREET STE A, CHINO CA., 91710 · (800)634-9166 · (909)628-4722 · FAX (909)591-2198

[www.yoshimura-rd.com](http://www.yoshimura-rd.com)

## **FENDER ELIMINATOR KIT**









**075BG137010**  
**Yamaha MT-07**

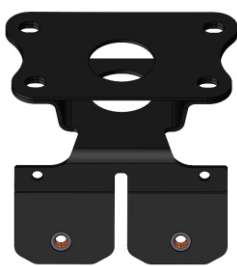

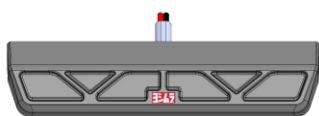
**THIS PRODUCT IS NOT DOT APPROVED.**

Yoshimura R&D of America, Inc. is not liable or responsible for any resulting event caused by the installation of this product. Check with local laws and regulations for compliance prior to installation and use. This product is not intended for use on public highways.

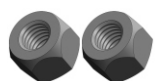

<p>#1 Qyt. 1</p>  <p>13701-FEBKT1 Fender Eliminator Bracket</p>	<p>#2 Qyt. 1</p>  <p>FE-LP-BKT License Plate Bracket</p>	<p>#3 Qyt. 1</p>  <p>075BG-LH-Y4 License Plate Light</p>	
<p>#4 Qyt. 1</p>  <p>13992-TSB-B1 OEM Turn Signal Bracket</p>	<p>#5 Qyt. 1</p>  <p>H-2158T Wire Debris Cover</p>	<p>#6 Qyt. 1</p>  <p>M6X12FS-SS 6mm x 12 mm Flat Head Screw</p>	
<p>#7 Qyt. 4</p>  <p>M6X10BHS 6mm x 10mm Button Head Screw</p>	<p>#8 Qyt. 2</p>  <p>M4X6BHS 4mm x 6mm Button Head Screw</p>	<p>#9 Qyt. 2</p>  <p>6MMWASHER-SS Stainless Washer</p>	<p>#10 Qyt. 2</p>  <p>6MMLN-SS Stainless Lock Nut</p>

### Service Parts & Accessories

[License Plate Frame](#)  
(070BG-LPF-K)

[Standard Turn Signal Kit](#)  
(075BG-STD-I-K)

[Sequential Turn Signal Kit](#)  
(075BG-SEQ-I-K)

[Micro Turn Signal Kit](#)  
(075BG-MIC-D-K)

[Black Ti Bolts](#)  
(M6X10-TI-BLK-K)

[Gold Ti Bolts](#)  
(M6X10-TI-GOLD-K)

[Oil Slick Rainbow Bolts](#)  
(M6X10-TI-OS-K)

### Assembly Diagram

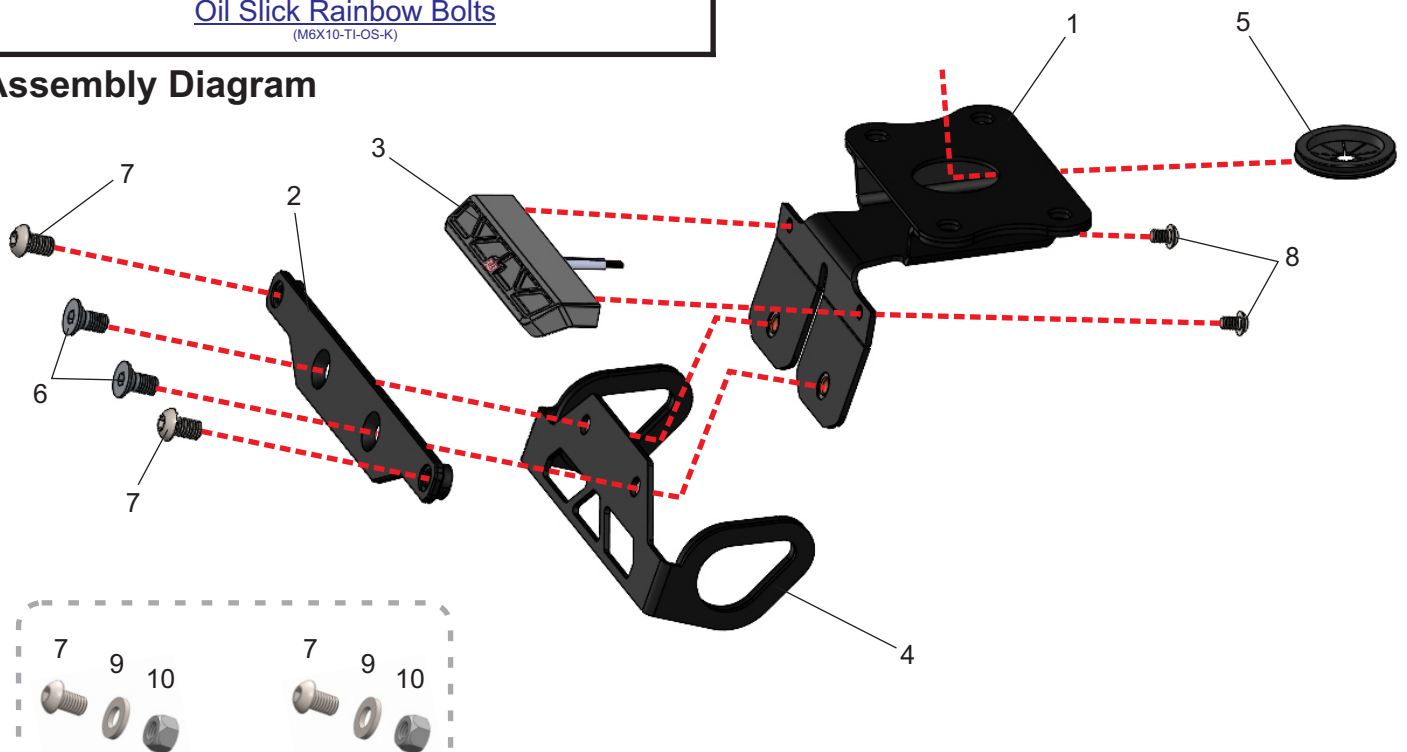

Button head screws, washers, and lock nuts are for the bottom two license plate holes.

## Removal

1. Remove passenger and rider seat.
2. Remove left and right tail fairings as per the Factory Service / Owners Manual.
3. Locate and disconnect license plate light and turn signal connectors.
4. While securely supporting the stock fender assembly, remove the four bolts securing the fender assembly to sub-frame. Carefully remove the stock fender assembly making sure not to damage the license plate light wire and turn signal connectors.
5. Remove the stock turn signals from the stock fender assembly.

## Installation

1. Install *H-2158T*, wire debris cover into the top hole of *13701-FEBKT1*, fender eliminator bracket.

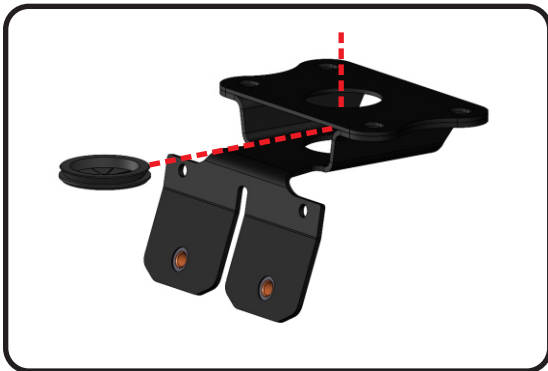

2. Install *075BG-LH-Y4*, Yoshimura license plate light onto *13701-FEBKT1*, fender eliminator bracket using *M4X6BHS*, 4mm button head screws.

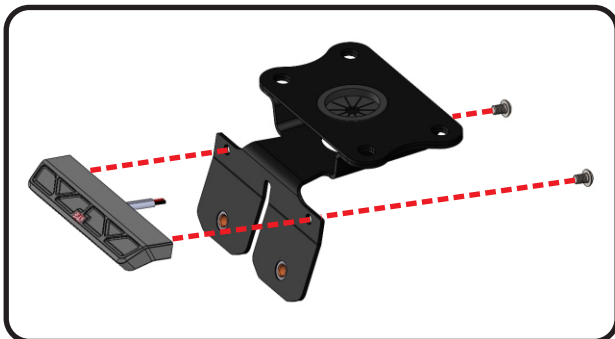

3. Install the stock turn signals onto *13992-TSB-B1*, OEM turn signal bracket using the stock mounting hardware.

NOTE: For turn signal kit installation, see appendix below.

\*\* [Standard / Sequential LED Turn Signal Kit](#) \*\*

\*\* [Micro LED Turn Signal Kit](#) \*\*

4. Install *13992-TSB-B1*, OEM turn signal bracket in between *FE-LP-BKT*, license plate bracket and the fender eliminator bracket using *M6X12FS-SS*, flat head screws.

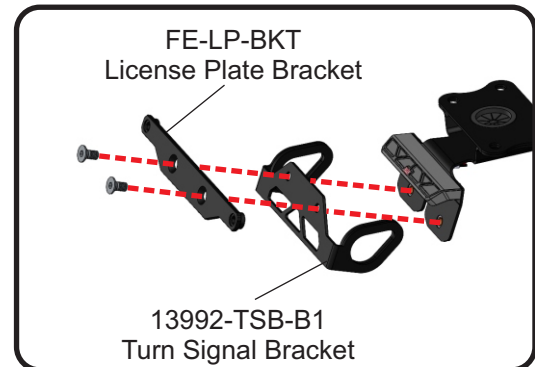

Note: *M6X10BHS*, button head screws will be used to secure the license plate to *FE-LP-BKT*, license plate bracket. *6MMLN-SS*, nylon lock nuts and *6MMWASHER-SS*, washers are for the bottom license plate holes.

5. Install the fender eliminator bracket to the sub-frame using the stock bolts.
6. Route the turn signal and license plate light connectors through the wire debris cover, under the passenger seat, and reconnect to the wiring harness.
7. Reinstall tail fairings and seats using the reverse steps of removal.
8. Check for proper function of the license plate light, turn signals, brake light, and that all brackets and components are secure prior to riding.