



YOSHIMURA

RESEARCH&DEVELOPMENT OF AMERICA, INC.

5420 DANIELS STREET SUITE A, CHINO, CA 91710 · (800) 634-9166 · (909) 628-4722 · FAX (909) 591-2198

www.yoshimura-rd.com

INS-32-K | YOSHIMURA RS-12 LOW VOLUME INSERT KIT

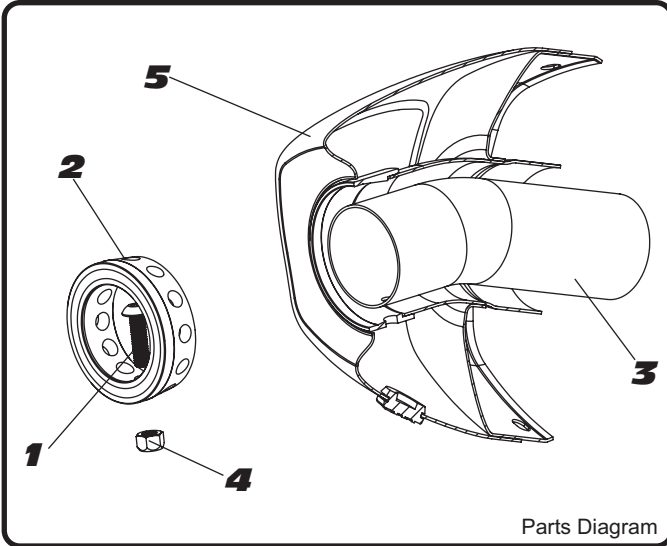

NO.	DESCRIPTION	QTY	PART #
1	5mm X 18mm Button Head Cap Screw	1	M5X18BHS
2	RS-12 Aluminum Insert Ring	1	YM1-RING-1375
3	Low Volume Sound Insert	1	INS-YM1-1375
4	5mm Lock Nut	1	5MMLN-U
5	Yoshimura Exhaust	**	**

1. Remove the insert grommet on endcap and remove button head screw using the aluminum ring and sound insert to the muffler.
2. Remove the sound insert from the muffler.
3. Install sound insert and aluminum ring and secure using insert button head screw.

Note: It is recommended that a low strength "Loc-tite" is used on the small allen head bolt.



YOSHIMURA

RESEARCH&DEVELOPMENT OF AMERICA, INC.

5420 DANIELS STREET SUITE A, CHINO, CA 91710 · (800) 634-9166 · (909) 628-4722 · FAX (909) 591-2198

www.yoshimura-rd.com

INS-32-K | YOSHIMURA RS-12 LOW VOLUME INSERT KIT

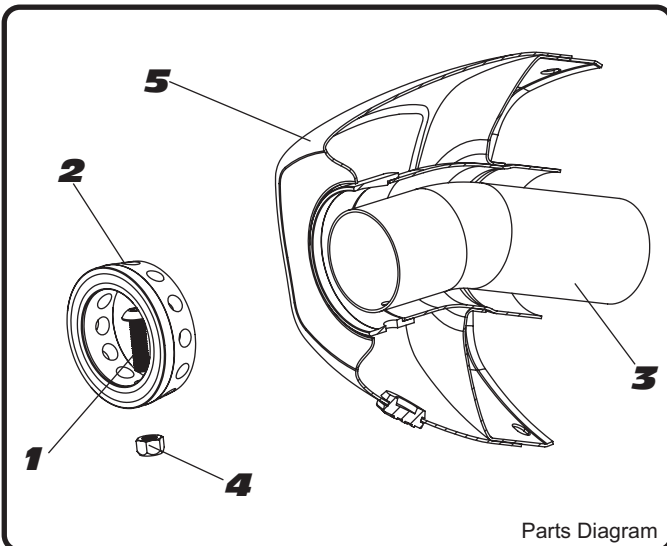

NO.	DESCRIPTION	QTY	PART #
1	5mm X 18mm Button Head Cap Screw	1	M5X18BHS
2	RS-12 Aluminum Insert Ring	1	YM1-RING-1375
3	Low Volume Sound Insert	1	INS-YM1-1375
4	5mm Lock Nut	1	5MMLN-U
5	Yoshimura Exhaust	**	**

1. Remove the insert grommet on endcap and remove button head screw using the aluminum ring and sound insert to the muffler.
2. Remove the sound insert from the muffler.
3. Install sound insert and aluminum ring and secure using insert button head screw.

Note: It is recommended that a low strength "Loc-tite" is used on the small allen head bolt.